

RECYCLED PACKAGING

# Handheld Digital Terminal USER'S MANUAL

## **Disclaimer**

We make every effort to keep the accuracy and integrity of this manual in the preparation process, but errors and omissions are inevitable. We do not assume any responsibility therefore. Due to the continuous development of technology, the product design and specifications are subject to change without notice. Reproduction, modification, translation and distribution of this manual in any form are prohibited without prior written authorization from our company.

All third party products and contents covered in this manual are the properties of the third party. We do not guarantee the accuracy, validity, timeliness, legality or completeness. For more information or any suggestions for this manual, please visit our website at <http://www.baofengradio.com>, or call our Service Hotline at 400-0123-353.

## **To users**

Thank you for your favor with our products.

BAOFENG is dedicated to providing high performance and high stability radio communication products. This two-way radio is no exception. DM-5R is a DMR dual time slot digital two-way radio with 1024 channels, dot matrix LCD display and full keypad hand tuning function developed and produced by BAOFENG team for civil consumer market. Please read this manual carefully in order to fully understand the superior performance and methods of use and maintenance of this unit.

### **RF radiation information**

This product is intended for professional applications that meet RF radiation requirements. Users must be aware of the hazards of RF radiation and take appropriate measures to meet the requirements of RF radiation limit.

### **Common sense in RF radiation**

RF refers to the electromagnetic frequency that can be radiated into space. It is a technology widely used in the fields of communication, medical treatment and food processing. It will produce some RF radiation in the course of use.

### **Control and operating instructions of RF radiation**

In order to maximize the performance of the product and to ensure compliance with the radiation limits in the relevant occupational or controlled environment of the above criteria, the sending time shall not exceed 50% of the rated factor and shall follow the instructions below:

- RF radiation is generated only during transmission (speech) rather than reception (listening) and standby.
- The distance between the terminal and the body during transmission should be at least 2.5 cm.

## **To users**

### **RF radiation information**

This product is intended for professional applications that meet RF radiation requirements. Users must be aware of the hazards of RF radiation and take appropriate measures to meet the requirements of RF radiation limit.

### **Common sense in RF radiation**

RF refers to the electromagnetic frequency that can be radiated into space. It is a technology widely used in the fields of communication, medical treatment and food processing. It will produce some RF radiation in the course of use.

### **Control and operating instructions of RF radiation**

In order to maximize the performance of the product and to ensure compliance with the radiation limits in the relevant occupational or controlled environment of the above criteria, the sending time shall not exceed 50% of the rated factor and shall follow the instructions below:

- RF radiation is generated only during transmission (speech) rather than reception (listening) and standby.
- The distance between the terminal and the body during transmission should be at least 2.5 cm.

## Main Features

- Digital-analog compatible, smooth transition  
Supports DMR digital and analog communication mode, and ensure smooth transition from original analog products to digital products to meet different communication needs
- DMO True2-Slot dual time slot  
Direct mode dual-slot communication achieves two groups of calls at a frequency point at the same time, so that the communication efficiency is doubled and frequency resources are saved
- Digital signaling function  
Rich calling modes that support DMR protocol, including single call, group call and all call; supports remote inhibit function and other applications
- SMS function  
Supports SMS, text editing and draft in 64 characters in Chinese and English, so that text messages calls can be sent when voice call is inconvenient
- High sound quality  
This digital two-way radio uses advanced AMBE +2TM voice processing technology to achieve high quality
- Wide frequency band talkback  
Reduces frequency band limitation (supports UHF400-480MHz / VHF136-174MHz)
- Manual writing-frequency  
Supports channel / frequency mode, allows manual writing-frequency in frequency mode, and writing-frequency

software can be used to set the required frequency without connecting the computer

- High/low power switch  
Meets the power requirements of different call distances to save more energy
- CTCSS/ CDCSS and tail tone elimination  
Integrates 50 sets of standard CTCSS and 210 sets of standard CDCSS, supports non-standard CTCSS/CDCSS, and the interference caused by common frequency and the crack sound caused by the end of the call and carrier wave can be eliminated after setting CTCSS or CDCSS
- Alarm function  
Supports general alarm and silent alarm in emergency situations
- Digital tuning FM radio (receiving frequency 65-108MHz)
- Digital mode supports the use of relays
- Side buttons can be customized without changing the user's operating habits
- Flashlight function

## User Safety Information

Please read the following information in order to use this two-way radio safely and efficiently.

1. The maintenance work of the two-way radio can only be carried out by professional technical personnel; assembly / disassembly without permission is prohibited;
2. To avoid problems caused by electromagnetic interference and / or electromagnetic compatibility, please turn off the two-way radio in places with the sign "Please turn off two-way radio", such as hospitals and other health care facilities.
3. When taking airplane, please turn off the two-way radio when the crew request.
4. In automobile with airbags, do not place the two-way radio in the inflation area of the airbags.
5. Turn off the two-way radio before entering the flammable and explosive environment;
6. Do not replace or charge the battery in flammable and explosive environments;
7. Turn off the two-way radio before approaching the blasting area and detonator area;
8. Do not use the two-way radio if the antenna is damaged, or else it may cause minor skin burns;
9. Do not expose the two-way radio to direct sunlight or near the heating device.
10. While the portable two-way radio is transmitting, keep the radio in a vertical position and keep the microphone about 5cm from the mouth.
11. Keep the two-way radio at least 2.5cm from the head or body during transmitting.
12. If you are wearing the portable two-way radio on your body, make sure that the antenna is at least 2.5cm away from the body when the two-way radio is transmitting.
13. If the two-way radio has any odor or smoke, turn off the power immediately and contact your dealer.

## Packing List

The packing box contains the following items. If any item is missing or damaged, please contact your dealer.

Host	Battery	Antenna	Charger	adapter	cable	user manual
1	1	1	1	1	1	1

**Note:** Please refer to the color ring label at the bottom of the antenna for antenna frequency band. If the label does not indicate a band, refer to the specific band on the host label.

## Familiar with this Product

You can familiarize yourself with the external structure and the functions of programmable buttons of this product in this section.

## Introduction of Parts

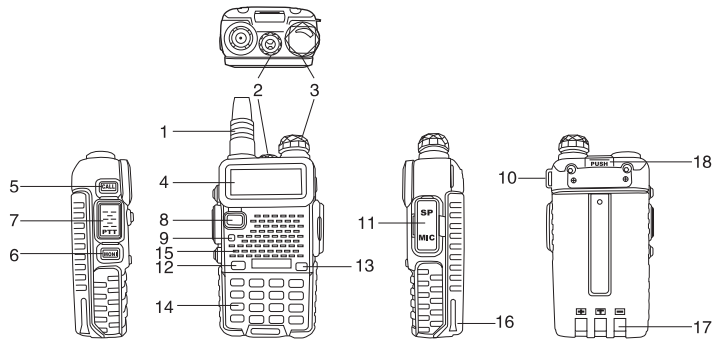

No.	Part Name
1	Antenna
2	Flashlight
3	Power switch / volume knob
4	LCD screen
5	CALL button (side button SK1, custom button 1)
6	MONI button (side button SK2, custom button 2)
7	PTT button (Transmit button)
8	VFO/MR button (frequency mode / channel mode switching button)
9	LED indicator
10	Lanyard buckle
11	Accessory interface (headset or programming interface)
12	A/B button (AB pointer switch button)
13	BAND button (band switching button)
14	Number keypad
15	Speaker
16	Battery
17	Electrode contacts
18	Battery push button

## Disclaimer

[PTT]Transmit button	Switch between transmission and reception; when transmitting, press this button and speak to the microphone; release the button to receive.
Side button 1	Press this button and release to turn on the radio function; press and release again to turn off the radio.
Defaults to [CALL] button	Press and hold it to enter the alarm mode, press and hold it again or press briefly to exit the alarm mode. If the current channel is digital and no alarm system is configured, the alarm function can't be started. During analog channel transmission, press and hold this button to transmit 1000Hz tone signaling.
Side button 2 Defaults to [MONI] button	Press to turn on the flashlight, press it again to make the flashlight flash, and press it again to turn off the flashlight. Press and hold it to turn on the monitor function (only support analog channels).
[VFO/MR] button	In the main interface, switch the frequency mode and channel mode. During analog channel transmission, press and hold this button to transmit 1450Hz tone signaling.
[A/B]button	In the main interface, switch the main channel and sub-channel, and the arrow pointing channel is the main channel. During analog channel transmission, press and hold this button to transmit 1750Hz tone signaling. In SMS input interface, switch the cursor to previous line. In radio interface, it means to descend the radio channel.

[BAND]button	Switch UHF / VHF band in VFO frequency mode in the main interface.
	During analog channel transmission, press and hold this button to transmit 2100Hz tone signaling.
	In SMS input interface, switch the cursor to next line.
	In radio interface, it means to ascend the radio channel.
0-9 number buttons	Return to the main interface in menu mode and non-editing status.
	Default: 0~9
	[0~9] code words in DTMF function
	Select punctuation marks or letters in Pinyin input method.
[MENU] button	If numeric shortcut function is set, you can press and hold this button to jump to the corresponding contact.
	Press it to activate the menu mode, enter the menu and press this button to select menu items.
	Press and hold it to enter the radio settings.
	Code word A in DTMF function
[▲] button	In radio interface, press to enter the radio frequency modification interface.
	Move up; change the scanning direction in scanning state.
	Code word B in DTMF function
	Move left in SMS editing interface.
[▼] button	Adjust the frequency upwards in radio interface.
	Move down; change the scanning direction in scanning state.
	Code word C in DTMF function
	Move right in SMS editing interface.
	Adjust the frequency downwards in radio interface.

[Exit] / [Clear] button	Clear the entered information in input state. Code word D in DTMF function
	In analog mode in main interface, press this button to turn on/off scrambling.
[*] button	In digital mode in main interface, press this button to enter manual dial interface.
	In VFO frequency mode, press and hold this button to start scanning.
	Analog channel enters the menu mute setting; press this button to start mute scanning.
	In radio mode, enter the search function, and store the searched signal to current radio channel automatically.
	Press this button to clear the data in message editing box.
	Code word * in DTMF function
[#] button	In the main interface, press this button to switch high/low power
	Press and hold this button to turn on/off keypad lock
	Switch the input method in input method interface.
	Code word # in DTMF function

**Note:** Four relay audio call signaling: press [PTT] + [CALL] to send 1000HZ signaling; press [PTT] + [VFO/MR] to send 1450HZ signaling; press [PTT] + [A/B] to send 1750HZ signaling; press [PTT] + [BAND] to send 2100HZ signaling.

## Programmable Buttons

In order to ease the operation, the two programmable buttons [SK1] and [SK2] can be programmed by your dealer as function shortcuts, as shown in the following table. For more information about each function, see the “Function and Operation” section.

No.	Shortcut name	Purpose
1	None	No function is assigned to the preset button.
2	Prompt tone on/off	Quickly enable or disable all prompt tones at the same time.
3	Emergency mode on	Quickly establish an emergency call. This is the recommended option for the orange button.
4	Emergency mode off	Quickly end an emergency call initiated outward.
5	Select high/low power	Quickly switch between high power and low power.
6	Monitor	Quickly turn on or off the monitor function.
7	Delete useless channels	Quickly delete useless channels from the scan list (except the selected channels).
8	Push to talk 1	Quickly make digital group calls, digital single call, call prompts, or send text messages (only for digital mode) via push to talk. (This option is only available if the digital function is enabled on the device.) Push-to-talk 1 to push-to-talk 6 can be set.
9	Relay / offline	Quickly switch between relay mode and offline mode.
10	Scan on / off	Quickly turn the scan function on or off. Note: double-segment double-waiting scan does not work



No.	Shortcut name	Purpose
11	Strict/normal squelch	Quickly switch between strict squelch and normal squelch (only for analog mode).
12	Encryption on/off	Quickly turn on/off encryption for channel (only for digital mode).
13	Voice control on/off	Quickly turn on or off the voice control function.
14	Area switching	Quickly select the area, allowing the user to switch between two areas.
15	Battery power indication	Quickly access to battery power. The user can check the battery status by LED. The battery power is sufficient if the LED is constantly in green, the battery power is still available if the LED is constantly in yellow, and the battery power is low if the LED is in red.
16	Individual operation switch	Quickly turn on or off individual operation function.
17	End call	Quickly end the phone call (only for digital mode).





**Note:** Depending on dealer setting, different functions can be achieved by pressing and pressing and holding the same button.

## Battery Voltage & Power Indication

This function allows you to check the current voltage and available power of the battery.

Press the [0] button to display the current voltage.

The upper right of the screen shows the current power; the power icons are as follows:

Battery icon	Battery power
	High
	Medium
	Low
	Insufficient

## Status Indication

### LCD Icons

The LCD screen is used to display all the working status of the two-way radio. The corresponding function icons are displayed on the screen during operation. The screen allows you to know the meaning of the icons and how to set the functions more quickly.

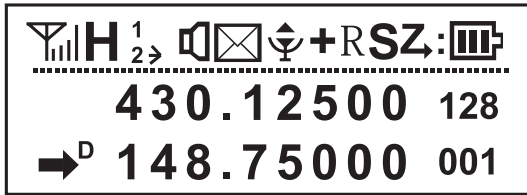

### Description of LCD Icons

Icon name	Icon	Description of product status
Signal strength icon		The more signal bars, the stronger the signal is
Transmission power icon	<b>H</b>	The current channel transmits at high power
	<b>L</b>	The current channel transmits at low power
Direct mode slot icon	<b>1</b> <b>2</b> ➔	The current channel is in double slot direct mode and slot 1 is active
	<b>1</b> <b>2</b> ➔	The current channel is in double slot direct mode and slot 2 is active
Sub-audio icon	<b>CT</b>	The current sub-audio is CTCSS
	<b>DCS</b>	The current sub-audio is CDCSS
Speaker icon		Speaker is enabled, and reception is effective
Narrowband mode	<b>N</b>	Work in narrowband mode
Message icon		Receive a text message, or have an unread message

Icon name	Icon	Description of product status
VOX icon		VOX has been turned on
Relay mode icon	<b>+</b>	The current transmission frequency is the reception frequency plus a frequency bias (positive bias)
	<b>-</b>	The current transmission frequency is the reception frequency minus a frequency bias (negative bias)
	<b>I-H</b>	Currently in offline state
Scrambling icon	<b>R</b>	The current reception frequency and the transmission frequency are inverted (if the reception sub-audio and transmission sub-audio are different, the sub-audio will also be inverted)
Double-waiting icon	<b>S</b>	Has been set to dual-band double-waiting function, and allows waiting on two frequency bands displayed on the screen at the same time
Scan icon	<b>Z</b>	The scan is on and is in normal mode
	<b>Z.</b>	The scan stays on priority channel 1
	<b>Z:</b>	The scan stays on priority channel 2
Battery power icon		The more bars, the more battery power
Pointer icon	<b>➔<sup>D</sup></b>	Currently pointing to the main digital mode; press A/B button to switch the main channel up and down. When double-waiting is turned on and works in digital sub-channel, the icon is ➔ <sup>D</sup>
	<b>➔<sup>A</sup></b>	Currently pointing to the main analog mode; press A/B button to switch the main channel up and down. When double-waiting is turned on and works in analog sub-channel, the icon is ➔ <sup>A</sup>
Channel number icon	001	In channel mode, the current channel number is 001 (range 001~128)

## LED Indicators

This product has LED indicators so you can easily grasp the current operating state.

Indicator	Product
status	status
Red on	Sending
Green on	Receiving

## Menu Navigation

Press the **[MENU]** button in digital mode or digital channel to enter the digital menu; press the **[MENU]** button in analog modem or analog channel to enter the analog menu. The menu structure is shown in the following figure, including all the menu items of this product. You can ask the dealer to configure the menu items. You need to first press the **[MENU]** button to enter the main menu, and then press the **[▲]** / **[▼]** button to navigate to desired submenu or option and press the **[MENU]** button to confirm and complete your setting. This document only describes the order of the menu items when the menu operation is introduced. For example, the path to the contact list is "Contacts -> Contact List". The menu has automatic reset function. If you do not do anything for the menu during preprogrammed time (configured by the dealer), the product will automatically return to the standby screen. You can ask the dealer to modify the auto reset time and cancel auto reset.

## Menu list

Level 1 men	Level 2 menu	Level 3 menu	Options	Description of settings	Remark	
Contacts	Contacts	Contact list	View contacts	View the contact name and number	For digital mode only	
			Quick configuration	Configure number 0~9 to the contact, select idle state to turn off shortcut configuration		
			Delete contact	Delete current contact		
	New contact	Enter number	xxx	Enter the contact number, up to 16777214, press the MENU button to confirm or press EXIT to delete		
			Alias	Abcd		Enter the name; support Chinese and English and special characters
			Tone	OFF Tone 1~10		There are 10 tones that can be selected. When the caller chooses to enable the call prompt and the caller' s number is the new contact, the unit issues this tone and the tone can be turned off if it is not necessary
	Manual dialing	Enter number	Call prompt	Send call prompt to a contact, and the other party can call back directly		
			Radio detection	Initiate radio detection to a contact without interfering with each other to confirm whether the other party has turned on the unit or uses in the current channel.		
			Remote monitoring	Remotely activate the microphone of a contact, and monitor the voice and background sound of the other party.		
			Radio activation	Send an activation command to a contact to resume normal use of the two-way radio.		
			Radio remote inhibit	Send a remote inhibit command to a contact, so that the radio can' t be used normally. Remote inhibited two-way radio can be remotely monitored, but other functions can' t be used; it only allows re-writing frequency through CPS software or activating the radio through activation instructions		

Level 1 men	Level 2 menu	Level 3 menu	Options		Description of settings	Remark
SMS	Inbox	Reception list	List xxxx		Unread ☒, read ☒; press MENU to edit the contents, and press MENU again to reply / forward / delete	For digital mode only; host computer menu option can be configured
		Delete all	Yes/No		Yes: Delete all; No: Do not delete	
	Write message	Edit interface			Support Chinese and English and special characters, press the # button to switch input method, and press MENU key to send / save / clear	
		Outbox	Outbox list	List...		
	Delete all				Yes: Delete all; No: Do not delete	
	Drafts	Draft list	List...		Press the MENU button to edit the content, and press MENU again to transmit / edit / delete	
		Delete all			Yes: Delete all; No: Do not delete	
Default message	List...			Press the MENU button to edit the content, and press MENU again to transmit / save / clear		
Call log	Called numbers	Dialed list	List...		Dialed single calls; press MENU to view / add to Contacts/ delete, enter alias and save in contact list	For digital mode only; host computer menu option can be configured
		Delete all			Yes: Clear dialed list, No: Do not delete	
	Answered calls	Answered list	List...		Answered single calls; press MENU to view / add to Contacts/ delete, enter alias and save in contact list	
		Delete all			Yes: Clear answered list, No: Do not delete	
	Missed calls	Missed list	List...		Missed single calls; press MENU to view / add to Contacts/ delete, enter alias and save in contact list	
		Delete all			Yes: Clear missed list, No: Do not delete	
Phone contact			List of contact names		Press the UP/DOWN button to select a contact name, then press the PTT button to send the selected contact DTMF number wirelessly, and press the EXIT button to return	For analog mode only

Level 1 men	Level 2 menu	Level 3 menu	Options		Description of settings	Remark
Settings	Radio settings	Sub-audio	Sub audio codec		Change the encoding and decoding of sub-audio. Press [MENU] to enter "Sub-audio codec" , press [A/B] to select digital sub-audio, press [▲] / [▼] to select digital sub-audio code, press # to switch the positive phase (N) and negative phase (I). ● Press [A/B] to select "Sub-audio codec OFF" , press [▲] / [▼] to select analog sub-audio frequency. ● You can also enter non-standard sub-audio manually with keypad, press the [MENU] button to confirm, and press [EXIT] to return.	For analog mode only
			Sub audio codec		Change the decoding of sub audio. Setting method is same as above	
			Sub-audio coding		Change the coding of sub audio. Setting method is same as above	
		Squelch	0~9		Squelch can be set to 0~9, 0 is the lowest and squelch is always on; 9 is the deepest, about -116dBm	Host computer menu option can be configured
		Transmission power	Low		Low power transmission	Options can be configured
			High		High power transmission	
		Offline	ON		ON; the function works only when "Allow offline" of current channel of the host computer is ticked	Options can be configured
			OFF		OFF	
		Broad band and narrow band	Narrow band		Narrowband works	For analog mode only
			Broad band		Broadband works	
		Busy lock	OFF		Transmit when the channel is occupied	
			Carrier wave		Press PTT to prohibit transmission when there is carrier wave	
			Sub-audio / color code		Match sub-audio / color code forbidden	
			OFF		Off, no transmission limit	

Level 1 menu	Level 2 menu	Level 3 menu	Options		Description of settings	Remark
Settings	Radio settings	Transmission time limit	15~495S		Alarm in 10 seconds before transmission, and prohibit transmission when the time is up; for example, when it is set to 60 seconds, alarm is sent for 10 seconds from the 50th second, and transmission is prohibited at the 60th second	Options can be configured
		Voice control	OFF		VOX is turned off;	
			ON		It is not necessary to press PTT when this option is on; you can speak to transmit directly; voice sensitivity of the host computer can be set to 1~10, level 1 is the highest sensitivity level, and level 10 is the lowest sensitivity level	
		Dual standby	OFF		Turn off dual standby, and switch upper and lower channels through the keypad; when the machine works in the main channel, the sub-channel can't transmit or receive	
			ON		Scan main channel and sub-channel in turn; call is locked when the reception is effective; you can press PTT to talk with the other party	
		Digital encryption	OFF		Turn off encryption	Options can be configured; for digital
			ON		Turn on encryption function, and the two sides must pair the key to make the call normally	
		Power saving switch	OFF		Turn off power saving mode	Options can be configured
			ON		Turn on the power saving mode; power saving ratio is 1:4	
		Prompt tone	All tones		Options: Off/On. Turn off all tones when Off is selected, but do not include emergency alarm tone	
Call permission			Options: Off / Digital / Analog. Pressing the PTT button will transmit the signal through the channel and will sound a tone that prompts the user to start speaking. ● OFF: Turn off this function			

Level 1 men	Level 2 menu	Level 3 menu	Options		Description of settings	Remark
Settings	Radio settings	Prompt tone	Call permission		<ul style="list-style-type: none"> <li>● Digital: Enable this tone only for digital channels</li> <li>● Analog: Enable this tone only for analog channels</li> </ul>	Options can be configured
			Touch-tone		Options: Off/On. There is no prompt tone when Off is selected	
			Call end tone		Options: Off/On. On: This feature will send prompt tone when the voice call is terminated.	
		Backlight	Normally on		Always on	
			5~15 sec		Turn off the backlight automatically when the time is up	
		Keypad lock	Manual		Press and hold # to lock, press and hold it again to unlock	
			5/10/15 sec		Auto lock; lock automatically at set time; press and hold # to unlock	
		Indicator	OFF		The indicator (transmission, receiving, boot, etc.) does not work when it is off	
			ON		Default option is on	
		Power on password	Enter password		Input correct password to enter the setup menu; the password can be configured by default on host computer Options: On or Off / Changes boot password <ul style="list-style-type: none"> <li>● On or Off: Turn on if it is turned off, and turn off if it is turned on; when On is selected, you need to enter the correct password and press the MENU button to start the unit</li> <li>● Change boot password: You can enter a new password not more than 6 digits; please remember after changing</li> </ul>	
		Mode selection	S/N display		The channel mode is displayed by channel number	
			Name display		The channel mode is displayed by channel name	
			Frequency display		The channel mode is displayed by frequency mode	
		Boot interface	Picture		Display according to the picture provided by the customer	
			Preset characters		Two lines, can be edited by host computer	



Level 1 men	Level 2 menu	Level 3 menu	Options		Description of settings	Remark	
Settings	Radio settings	Language selection	English		English version, including menu, call tips, call logs and all other interfaces		
			Chinese		Simplified Chinese		
		DTMF caller ID	ON		When DTMF caller ID is turned on, the caller ID is displayed when there is incoming call; calling format: caller ID separator own ID		
			OFF		OFF		
		DTMF side tone	OFF		When DTMF codeword is sent, the unit does not make sound		
			ON		When DTMF code word is sent, the unit makes the sound		
		Scan recovery mode	Time scan		Time mode scan; continue scanning in 5 seconds after signal is searched		
			Carrier scan		Carrier mode scan; wait for 5 seconds after the carrier disappears before continuing scanning when signal is searched		
			Search scan		Search mode scan; stop scanning when signal is searched		
		PTT online/offline code	None		Do not send code when PTT is pressed		
			Online code		Press PTT to send code; online code word is set by the host computer		
			Offline code		Release PTT to send code; offline code word is set by the host computer		
		Delay in sending code	100~1000ms		Send code when it is pressed or released		For analog mode only
		Delay in sending code	100~1000ms		The delay time before automatic transmission		
		Selecting dual waiting	Main channel Reception channel		Press PTT in dual waiting state, the transmission frequency band depends on the frequency band pointed by the cursor of current band		

Level 1 men	Level 2 menu	Level 3 menu	Options		Description of settings	Remark
Settings	Radio settings	Selecting dual waiting	Reception channel		Press PTT in dual waiting state, the transmission frequency band depends on the effective reception frequency band; in non-receiving state, press PTT to transmit in main channel frequency band	For analog mode only
		Signaling tail tone elimination	Frequency		Analog with sub-audio signaling, release PTT to send sub-audio tail tone elimination signaling	
			120°		Analog with sub-audio signaling, release PTT to send 120° phase sub-audio signaling	
			180°		Analog with sub-audio signaling, release PTT to send 180° phase sub-audio signaling	
			240°		Analog with sub-audio signaling, release PTT to send 240° phase sub-audio signaling	
		Non-signaling tail tone elimination	OFF		Turn off tail tone elimination	
			Frequency		Analog without sub-audio signaling, release PTT to send sub-audio tail tone elimination signaling	
		Across-relay tail tone elimination	OFF		OFF	
			1~10		Step: 1 (500ms) When transmitting across the relay and retransmitting, after the transmitter releases the PTT key, the two-way radio enters receiving state. Due to the delay of relay, the instant signal transmitted by the relay can be received. The value of the menu item shall be adjusted to ensure that no noise of this two-way radio is generated when transmitting across the relay, so as to confirm whether the relay is operating. The menu item shall be set OFF.	
		Relay tail tone delay	OFF		OFF	

Level 1 men	Level 2 menu	Level 3 menu	Options		Description of settings	Remark
Settings	Radio settings	Relay tail tone delay	1~10		Step: 1 (200ms) When the signal is transmitted across the relay station and retransmitted by it, in order to confirm whether the relay station has retransmitted the signal for this two-way radio, the delay time of the relay station stopping transmitting shall be utilized to confirm that the signal has been retransmitted. The menu item is used to adjust the time of the noise. If the noise isn't needed, please set it as OFF	For analog mode only
		Channel storage	Input 001~128		To save a channel, manually enter the channel number to be saved. If the input channel has a parameter, the word "CH" appears at the top right of the screen. When the range is exceeded, it prompts "channel number incorrect"	
		Channel deletion	Input 001~128		To delete a channel, manually enter the channel number to be deleted. If the input channel has a parameter, the word "CH" appears at the top right of the screen. When the range is exceeded, it prompts "channel number incorrect"	
		Own number	12345678		Digital mode displays the digital ID of the unit, up to 16777214; analog mode displays the DTMF ID of the unit, up to 999999999; this option is read only	
		Device info	Model info		The machine model	For digital mode only
			S/N		Unique alphanumeric character of the two-way radio	
			CPS version		Reading and writing frequency software version	
			Hardware version		Hardware circuit board version	
			Firmware version		The software version of the internal hardware components of the two-way radio	
			DSP version		DSP software version number of digital processing chip	
Programming time		The date and time of the last programming of the two-way radio				

Level 1 men	Level 2 menu	Level 3 menu	Options	Description of settings	Remark
Settings	Radio settings	Radio configuration	Reception frequency	To set reception frequency; press * to clear all, press EXIT to delete one	
			Transmission frequency	To set transmission frequency; press * to clear all, press EXIT to delete one	
			Channel name	To set channel name; press * to clear all, press EXIT to delete one	
			Color code	Options: 0~15 optional Valid for digital mode only	For digital mode only
			Time slot	Options: 1~2 optional Valid for digital mode only	
			Difference frequency	000000~50000K, the minimum step value is 50K The difference between transmission frequency and reception frequency in frequency mode, whether frequency has difference depends on frequency direction	
			Difference frequency direction	Options: Off / Positive / Negative <ul style="list-style-type: none"> <li>● Off: Transmission frequency and reception frequency have no difference in frequency mode</li> <li>● Positive: In frequency mode, the transmission frequency is equal to the reception frequency plus the difference frequency</li> <li>● Negative: In frequency mode, the transmission frequency is equal to the reception frequency minus the difference frequency</li> </ul>	
			Frequency step	Options: 2.5K/5.0K/6.25K/10K/12.5K/25K/50K In the frequency mode, press [▲] / [▼] to adjust the frequency value in steps; scanning steps in frequency mode	

Level 1 men	Level 2 menu	Level 3 menu	Options		Description of settings	Remark
Settings	Radio settings	Radio configuration	Channel type		Options: Analog / Digital Switch analog and digital mode in frequency mode	
Region	Region name				A list of regions that can support up to 250 regions	
Scan	Switch				Switch on/off; scan function can be turned on only when the PC of current channel has configured the scan list; it also can be turned on through the function button defined as "scan switch"	Host computer menu option can be configured
	Scan list				Display the current scan list, which is read only	

## Input Method

You can enter user aliases, numbers and text messages via the keypad. This product supports the English input method, Simplified Chinese Pinyin input method, and number input method.

### Simplified Chinese Pinyin Input Method

1. Press [#] to switch to Pinyin input method (LCD shows PY).
2. Press number buttons to enter the pinyin, and the LCD shows the alternate pinyin and corresponding candidate Chinese characters.
3. Press [▲]/[▼] to select the desired pinyin.
4. Press the [MENU] button to move the highlight to the Chinese character area, and press [▲]/[▼] to select the desired Chinese character.
5. Press the [MENU] button to enter the selected Chinese character. Repeat the above steps to complete the input.

### English Input Method

1. Press [#] to switch to uppercase (LCD shows ABC) or lower case (LCD shows abc) English input method.
2. Press the number buttons repeatedly until the desired letter appears. Repeat the above steps to complete the input.

### Number Input Method

1. Press [#] to switch to number input method (LCD shows 123).
2. Press the number buttons 0~9 to enter the corresponding number.

### Input Special Characters

Press number button [1] to enter commonly used punctuation

and special characters. To enter a space, press the [0] button.

**Note:** In the input text display area, press [▲]/[▼] to move the cursor left / right.

## Basic Operation

### Turning on/off

To turn on the power, turn the [Power switch / volume control] knob clockwise until you hear a “click”. To turn off, turn the knob counterclockwise until you hear a “click”.

### Adjusting Volume

After turning on, turn the [Power switch / volume control] knob clockwise to increase the reception volume, and turn counterclockwise to reduce the reception volume.

### Selecting Region

Region is a channel group in which you can include channels with the same attributes (such as call type, digital mode and analog mode) in a region, which makes it easy for you to manage existing channels. The unit supports up to 250 regions, and each region contains up to 16 channels. You can select a region in two ways:

- Select from the menu: After entering the “Region” menu, press [▲]/[▼] to select the desired region, and then press [MENU] to switch to the selected region.

- Select through the programming button: If the dealer has set the [Regional switch] shortcut, you can press the shortcut to switch to the desired region.

### Selecting Channel, User ID & Call Group ID

In the standby interface, press [VFO/MR] to switch to MR (channel) mode, and press [ ▲ ] / [ ▼ ] to select the desired channel, user alias or ID, or call group alias or ID.

### Setting Frequency Manually

In the standby interface, press [VFO/MR] to switch to VFO (frequency) mode, in which you can perform operations such as inputting frequency manually and saving channels.

### VFO Mode

VFO mode is the basic mode for changing the operating frequency. In the standby interface, press [VFO/MR] to switch to VFO mode, and press [ ▲ ] / [ ▼ ] to increase or decrease the frequency.

### Quick Frequency Input

In addition to pressing [ ▲ ] / [ ▼ ], you can also input the frequency directly. If the required operating frequency is far from the current frequency, you can use the keypad to directly input the frequency.

- Press [VFO/MR] to switch to VFO mode.

- The frequency must be entered directly in VFO mode.
- Press the number buttons ([0] to [9]) to enter the desired frequency.
- After entering the frequency manually, press and hold the [PTT] button to call the contact of current frequency.

### Digital - Analog Switching

Each channel of this product can be configured by the dealer as an analog channel or a digital channel. If the current region contains a digital channel and an analog channel, you can change the channel to an analog or digital.



### Dual Mode Switch

Press [A/B] to switch the upper and lower pointers, and the solid pointer  points to the main channel.

Dual-stage operation mode can be selected through the menu; the path is as follows:

Enter "Menu -> Settings -> Radio Settings -> Dual Standby" (Off / On).

- When dual standby is "off", the machine operates in dual-stage single waiting mode. The machine only works on the main channel, and the sub channel does not receive signal.
- When "dual-stage dual waiting" is selected, the main channel and sub channel scan in turn. When effective reception signal is scanned, the machine locks and works; if the locked channel is not the main channel,  points to the temporary working

channel, and  disappears when the preset time is up. If there is no temporary identification, the main channel pointed by  transmits when you press PTT (you can also set the active channel to transmit)

Note: As the dual waiting mode is in main channel and sub channel scanning states, DTMF, auto scan, individual operation and ARTS auxiliary function do not work.

### Keypad Lock & Unlock

If the keypad isn't needed, you can lock into prevent misuse. You can lock or unlock the keypad in the following ways:

- Shortcut

Press and hold the [#] button to lock or unlock the keypad.

- Menu selection

Enter "Menu -> Settings ->Radio Settings -> Keypad Lock", select "Manual" or "5 sec (or 10 sec, or 15 sec)"to lock it automatically.

»Manual: Press and hold the [#] button to manually lock or unlock the keypad.

»5 sec /10 sec /15 sec: If there is no radio operation in the auto-lock time, the keypad will automatically lock.

Note: The default keypad lock range is all buttons on the panel, excluding the side buttons SK1, SK2 and PTT.

## Call

### Call icon

The following icons displayed on the LCD appear in the contact list or call log to indicate the ID type.

 Single call: In the contact list, it indicates the signed user alias (name) or ID (number).

 Group call: In the contact list, it indicates the group alias (name) or ID (number).



 All call: In the contact list, it indicates the group alias (name) or ID (number).

Please keep the microphone about 2.5~5 cm from the mouth in order to ensure the best reception volume of the receiver's two-way radio.

### Single call

Single call is a call from an individual two-way radio to another.

### Initiate a Call

You can initiate a single call in the following ways. When the single call starts, the LCD screen displays : The first line shows Single Call, the second line shows the contact alias, and the third line shows the single call number and the call icon .

Initiate a Call by Channel Switching

In the standby interface, press [VFO/MR] to switch to channel mode, use the [▲] / [▼] buttons to select the channel, press and hold the [PTT] button to initiate single call.



### Initiate a Call to Default Contact

In the standby interface, press and hold the [PTT] button to initiate a single call on a contact preset on the current digital channel.

**Note:** You can ask the dealer to preset a contact for each digital channel. The contact can be a single call contact, or a group call or all call contact.

### Initiate a Call through the “Contact list” or “Call log”

1. Select “Contacts -> Contact List” or select “Call log” to enter the list of dialed / answered / missed calls.
2. Use the [▲] / [▼] buttons to select the single call contact you want to call.
3. Press and hold the [PTT] button to initiate a single call.

### Initiate a Call by Manual Dialing

1. Select “Contact -> Manual Dial” to enter the dialing interface.
2. Enter the single call number you want to call.
3. Press and hold the [PTT] button to initiate a single call.

**Note:** When the product allows entry through numeric keypad, you can directly press the [\*] button in the standby interface to enter the manual dialing interface, enter the single call number, and then press the [PTT] button to initiate a single call.

### Receive and Reply to a Call

After receiving a single call, the LCD screen displays  :

first line shows Single Call, the second line shows the contact alias and the third line shows the caller ID and the incoming call icon .

Press and hold the [PTT] button in the present time to send a callback. If a callback is not made, a missed call prompt is displayed to alert you.



Note:

- Select “Call log” to enter the dialed / answered / missed call list to view the call log.
- While viewing the call log, press and hold the [PTT] button to call back.

### Group call

To initiate a call to a user group, the two-way radio must be configured to the call group.

### Initiate a Call

You can initiate a group call in the following ways. When the group call starts, the LCD screen displays  : The first line shows Group Call, the second line shows the contact alias, and the third line shows the group call number and the call icon .

### Initiate a Call by Channel Switching

In the standby interface, press [VFO/MR] to switch to channel mode, use the [▲] / [▼] buttons to select the channel, press and hold the [PTT] button to initiate group call.

### Initiate a Call to Default Contact

In the standby interface, press and hold the [PTT] button to initiate a group call on a contact preset on the current digital channel.

### Initiate a Call through the “Contact list”



1. Select “Contacts -> Contact List”.
2. Use the [▲] / [▼] buttons to select the group call contact you want to call.
3. Press and hold the [PTT] button to initiate a group call.

### Initiate a Call by Manual Dialing

1. Select “Contact -> Manual Dial” to enter the dialing interface.
2. Enter the group call number you want to call.
3. Press and hold the [PTT] button to initiate a group call.

**Note:** When the product allows entry through numeric keypad, you can directly press the [\*] button in the standby interface to enter the manual dialing interface, enter the group call number, and then press the [PTT] button to initiate a group call.

### Receive and Reply to a Call

After receiving a group call, the LCD screen displays  : The first line shows Group Call, the second line shows the contact alias and the third line shows the caller ID and the incoming call icon .



Press and hold the [PTT] button in the pre-set time to send a callback.

### All Call

All call is that a single two-way radio calls all two-way radios on the channel. It is widely used to publish important notices that require special attention from users.



### Initiate a Call

There are two ways to initiate all call: Initiate a call to preset contacts or through the “Contact list”. The specific method is same as “initiate group call “described above.

When all call starts, the LCD screen displays  : The first line shows All Call, the second line shows the contact alias, and the third line shows the all call number and the call icon .

**Note:** You can initiate all call only when the dealer has enabled this function.

### Receive a Call

After receiving all call, the LCD screen displays  : The first line shows All Call, the second line shows the contact alias, and the third line shows the caller ID and the call icon .

### Note:

- You can't reply to the received all call.
- After receiving all call, if you switch to another channel, the radio stops receiving all call. During all call, you can't use the preprogrammed button until the call ends.

### Analog Channel Call

To transmit on the analog channel, press and hold the [PTT] button and speak to the microphone. To receive, release the [PTT] button.

## DTMF

### DTMF Call

Initiate a Call:

- In analog mode, press and hold the [PTT] button and press the number buttons on the panel.
- Press the [MENU] button to select a contact, and press the [PTT] button to start DTMF call.

### Receive a Call

When the host computer configures the receiving signal system of the current channel to DTMF, the decoding is successful when the codeword is DTMF personal ID code. You can make call with the other party in the reset time and the code word should be re-decoded when the reset time is up.

### PTT ID Call

#### Initiate a Call

In analog mode, you can configure the DTMF online code and offline code through host computer and enable online code and offline code for analog channel, or set by (MENU Settings → Radio Settings → PTT Online/Offline Code Option). When the

online code is enabled, the online code is sent when you press the [PTT] button, and the offline code is sent when the [PTT] button is released.

### Time-out Timer

This feature prevents the user from occupying the channel for too long. If the continuous transmission time exceeds the time set by the dealer, the product will stop transmission and send alarm. To stop the alarm tone, release the [PTT] button. To re-transmit, press and hold the [PTT] button again after a period of time (set by the dealer).

If the dealer sets the pre-alarm function, a pre-alarm prompt will be made before the time set by the timeout timer is up to tell you that the transmission will be disabled.

**Note:** This function is disabled in emergency alarm mode.

### Busy Channel Lockout

This function can be enabled by writing-frequency software to prevent interference with other users that are transmitting on the same channel. If you press and hold the [PTT] button while other users occupy the channel, the product will beep and display “Transmission failed, sub-audio disabled” or “Transmission failed, color code disabled”, prompting that transmission is disabled at this time. When the channel is idle, you need to press and hold the [PTT] button to transmit.

### **Voice Control**

Voice control refers that the voice can directly trigger PTT transmission: When the microphone detects that the voice reaches the level to trigger the voice-activated transmission, the two-way radio automatically transmits the voice, that is, the user does not have to press the [PTT] button during the call.

When the voice control is on, the LCD shows the icon .

### **Turn on/off Voice Control**

Press [Voice Control] shortcut to turn on/off the voice control function.

You can also turn on/off voice control in "Settings ->Radio Settings -> Voice Control".

Note:

- Please adjust the voice gain level correctly according to the current environment and normal speaking volume, so as to avoid frequent accidental triggering (sensitivity too high) or difficult to trigger voice control (sensitivity too low).
- The sensitivity of voice control transmission can be modified by writing-frequency software, level 1 is the highest sensitivity level, and level 10 is the lowest sensitivity level.

## **Functions and Operation**

### **Standby Interface**

This feature allows you to quickly return to the previous menu or standby interface.

In the editing interface, press the [EXIT] button to exit the editing interface, and return to the previous menu. Press the [BAND] button in any menu interface to return directly to the standby interface.

### **Manage Contacts**

You can manage your contacts through the "Contacts" menu of this product.

### **Contact List**

The contact list is used to save contact information and can store up to 512 records. You can access the "Contact list" from the "Contacts" menu, or press the [Contact list] shortcut to quickly access the "Contact list".

### **Extended Functions**

You can do the following for a contact in the contact list (single call contacts only): call prompt, radio detection, remote monitor, radio activation, or radio Inhibit. See the "Manual Dialing" section below.

### **Edit Contact**

You can modify the number and alias of a contact (single call contacts only) in the contact list.

### **View Contact**

You can view the contact details.

### Delete Contact

You can delete a contact (single call contacts only) in the contact list. The contact list must have at least two records, and you can't delete the default contact for the current channel.

### New Contact

This menu allows you to create a new contact (single call contacts only) to the contact list. The alias and number of all contacts must be unique, and the range of entered contact number is 1~16776415.

#### Note:

- When entering a contact alias, you can press the [#] button to toggle the input method.
- In addition to creating contacts through this menu, you can also save numbers in the call log to the contact list.

### Manual Dialing

In the digital mode, press the "\*" button to enter manual dialing, then you can manually enter a single call number, and press PTT to transmit; you can also enter a single call number, and press the [Menu] button to perform operations such as call prompt, radio detection, remote monitor, radio activation, and radio inhibit.

For single call ID, you can also perform the following options:

Extended functions	Send call prompt to a contact, and the other party can call back directly
--------------------	---

Radio detection	Initiate radio detection to a contact without interfering with each other to confirm whether the other party has turned on the unit or uses in the current channel.
Remote monitoring	Remotely activate the microphone of a contact, and monitor the voice and background sound of the other party.
Radio activation	Send an activation command to a contact to resume normal use of the two-way radio.
Radio remote inhibit	Send a remote inhibit command to a contact, so that the radio can't be used normally. Remote inhibited two-way radio can be remotely monitored, but other functions can't be used; it only allows re-writing frequency through CPS software or activating the radio through activation instructions

### SMS

This product supports DMR data function, and allows sending and receiving messages; the maximum length of each message is 144 characters.

### Edit and Send Messages

1. Select "SMS ->Write SMS" to enter the SMS editing window.
2. After editing the content, press the [MENU] button.
3. Select Send (or Save, or Clear) and press the [MENU] button.

4. Select the contact or enter the contact number manually.  
5. Press the [MENU] button to send the message, and the screen displays "Sending message...". After sending successfully, the interface will prompt "Sent successfully" and return. If sending failed, it displays "Message sending failed" and returns.

You can also use "Preset messages" to send, and forward the messages in inbox, outbox and drafts.

### **New Message**

After entering this menu, you can edit a new message, which supports up to 144 characters. After editing, you can save the message directly to the drafts or send it to an individual or group.

### **Preset Message**

This menu has messages pre-set by the dealer. This product supports up to 32 shortcut messages. You can choose a shortcut message to send directly, or edit the message and then send.

### **Inbox**

This product will save the received message in the Inbox. Each message has a corresponding icon to indicate whether the message has been read.

 : Indicates a read message.

 : Indicates unread message.

This product can store up to 20 received messages. If the Inbox is full, the icon  will be displayed on the LCD. If a new message is received, the earliest message will be overwritten automatically.

- You can perform the following operation for any message in the inbox: Reply, forward, details, and delete.
- If you want to delete all messages in the inbox, select "SMS -> Inbox -> Delete All".

### **Outbox**

This product will save the sent messages in the Outbox. The sent messages are always placed at the top of the Outbox list. This product can store up to 16 sent messages. When the Outbox is full, no icon will be displayed on the LCD. If there is a new text message, the earliest message will be overwritten automatically.

- You can perform the following operation for any message in the Outbox: Re-send, forward, edit and delete.
- If you want to delete all messages in the Outbox, select "SMS -> Outbox -> Delete All".

### **Drafts**

This product will save the edited messages in the drafts and support up to 20 draft messages. When the Drafts are full, if a new message is saved to the drafts, the earliest messages will

be overwritten automatically.

You can perform the following operation for any message in the drafts: Send, edit, and delete

- When you send the message in the drafts, this product will save this message to the Outbox and delete it from the drafts.
- If you want to delete all messages in the drafts, select “SMS -> Drafts -> Delete All”.

### Call Log

This product can store up to 10 recently dialed / answered / missed calls. When the call log is full, the earliest record is automatically overwritten if there is a new call log.

**Operation method:** You can enter the “Call log” menu via the [MENU] button, path: “Call log”; you can also quickly enter this menu via the [Call log] shortcut.

You can perform the following operation for any call log in the list:

- Press [PTT] to initiate a call, add to contact list, and delete.
- To delete all dialed / answered / missed call logs, select “Call Log ->Dialed / Answered/ Missed Calls -> Delete All”.

### Scanning

The scanning function helps you listen to the communication activity on other channels and comprehend the current activity of the relevant team members.

**NOTE:** The scanning function must be used when dual waiting is disabled.

### Method of operation

- You can select to turn on scanning through the “Scan” menu. Or press the [\*] button in the standby interface to turn on scanning. Or if the “Auto Scan” feature is enabled for a channel, the two-way radio will automatically turn on scanning when switching to that channel.

- After the scan is turned on, the two-way radio will scan according to the scan list set on the channel where the scan is on. The scanning process is as follows:

»When scanning, the icon **Z** is displayed on the screen, and the LED flashes slowly in orange.

»When activity is scanned on a channel, the two-way radio will stay on the channel. If the scan stays on a non-priority channel, the icon **Z:** is displayed on the screen. If the radio stays on priority channel 1 or 2, the icon **Z.** or **Z:** is displayed.

If you do not need to listen to the activities on the channel, press the [Delete useless channel] shortcut to temporarily delete the channel when scanning stops.

If you want to continue to listen to the activities on the channel, press the [MONI] shortcut while scanning stops.

To exit scanning, press the [\*] button again, or choose to turn off scanning in the “Scan” menu.

### Scan Settings

You can ask the dealer to create a scan list for each channel. This product can add up to 16 scan lists. Each scan list contains

up to 16 channels, either digital or analog. You can set the scan list as follows by using this product.

Menu path: Scan -> Scan list.

- Add channel

Add a new channel to the current scan list.

- Set priority channel

You can set the currently selected channel as a priority channel or a non-priority channel. If you want to focus on activities on a channel, set it as a priority channel. The sweep frequency of the priority channel is higher than that of non-priority channel. You can set up to two priority channels in each scan list, expressed as priority channel 1 and priority channel 2.

- Delete channel

Delete a channel in the current scan list, but you can't delete the first channel in the list.

#### Sub-audio Scan

This product supports sub-audio scanning function. Operation path: In analog mode, press the [MENU] button -> Settings -> Radio Settings -> Sub-audio Codec or Sub-audio Decoding -> press the [\*] button to enable sub-audio scan in sub-audio setting mode

Note: Enable CTCSS scanning in CTCSS mode, and enable scanning in DCS mode.

### High/Low Power Adjustment

This feature enables fast switching of high and low power. When the communication distance meets your needs, you can select low power to save power. Please select high power flow power does not allow you to communicate with other two-way radios farther away.

Press the [#] button to switch the transmission power of the current channel between high and low.

**Note:** The power level of each channel needs to be set separately.

### Offline

In case of a turntable failure or beyond the coverage of the turntable, but the two terminals are in the communication range of the other party, you can press [Offline] shortcut to switch to direct mode to achieve direct call of two terminals. Press the [Offline] shortcut to turn on the offline function (rising alert tone); press the button again to turn off this function.

### Monitor

Turn on the "Monitor" function to adjust the signal reception match condition.

- Press and hold the [Monitor] shortcut to turn on this feature, and the LCD shows icon  ; release the button to exit.

### Squelch Level Adjustment

You can adjust the signal strength required to receive the signal



by adjusting the noise level. In general, the higher the squelch level, the higher the required signal strength is. If it is set to "Normally on", the speaker will directly turn on to play the background sound, regardless of whether the decoding conditions are met.

### **Push-to-call**

You can ask the dealer to set [Push-to-call] shortcut, and press the shortcut to initiate the corresponding operation. Specific operation categories are as follows:

Business on digital channels:

» For group call contacts, you can initiate a group call or send text message.

» For single call contacts, you can initiate single call, send text message, and initiate extended function. Extended functions include: call prompt, radio detection, remote monitor, activation, and remote inhibit.

### **Call prompt**

In digital mode, you can send call prompt to a contact, and the other party can call back directly

#### ● **Initiate call prompt:**

Select single call contact (enter "Menu -> Contacts -> Press [▲] / [▼] to select single call contact -> Call prompt"), or press the \* button in the main interface to enter single call number, select "Call prompt", and press the [MENU] button to start; "Call prompts successful" displays if it is successful, and "Call prompt failed" displays if fails.

#### ● **Receive call prompt:**

After receiving the call prompt command, a tone rings (tone function is enabled for the caller's contact in the contact list) and stays in the display interface. Press [EXIT] to exit.

### **Radio detection**

In digital mode, you can initiate radio detection to a contact without interfering with each other to confirm whether the other party has turned on the unit or uses in the current channel.

#### ● **Initiate radio detection:**

Select single call contact (enter "Menu -> Contacts -> Press [▲] / [▼] to select single call contact -> Radio detection"), or press the \* button in the main interface to enter single call number, select "Radio detection", and press the [MENU] button to start; "Radio detection is successful" displays if it is successful, and "Radio detection failed" displays if fails. When the radio detection is successful, press PTT to call the other party.

#### ● **Receive radio detection:**

Reply automatically after receiving radio detection command.

### **Remote monitoring**

In digital mode, you can remotely activate the microphone of a contact, and monitor the voice and background sound of the other party.

#### ● **Initiate remote monitor:**

Select single call contact (enter "Menu -> Contacts -> Press [▲] / [▼] to select single call contact -> Remote monitor"), or press the

\* button in the main interface to enter single call number, select "Remote monitor", and press the [MENU] button to start; "Remote monitor is successful" displays if it is successful, and "Remote monitor failed" displays if fails. When the radio detection is successful, you can monitor the background sound and voice of the other party.

- **Receive remote monitor:**

After receiving the remote monitor command, it automatically starts transmitting voice and surrounding environment background sound, and exits automatically when the transmission time is up.

Note: This function works only if the function is set and turned on by writing-frequency software.

### **Radio activation**

In digital mode, you can send an activation command to a contact to resume normal use of the two-way radio.

- **Initiate radio activation:**

Select single call contact (enter "Menu -> Contacts -> Press [▲] / [▼] to select single call contact ->Radio activation"), or press the \* button in the main interface to enter single call number, select "Radio activation", and press the [MENU] button to start; "Radio activations successful" displays if it is successful, and "Radio activation failed" displays if fails.

- **Receive radio activation:**

After receiving the radio activation command, send activation tone, re-shutdown and then boot. It can also be activated by

writing frequency software.

**Note:** This function works only if the function is set and turned on by writing-frequency software.

### **Radio remote inhibit**

In digital mode, you can send a remote inhibit command to a contact, so that the radio can't be used normally.

- **Initiate inhibit:**

Select single call contact (enter "Menu -> Contacts -> Press [▲] / [▼] to select single call contact ->Radio inhibit"), or press the \* button in the main interface to enter single call number, select "Radio inhibit", and press the [MENU] button to start; "Radio inhibit is successful" displays if it is successful, and "Radio inhibit failed" displays if fails.

- **Receive inhibit:**

After receiving the radio inhibit command, send inhibit prompt tone, and press the [PTT]button to display "Transmission failed and inhibited". It can be activated by SMS writing frequency or wake-up.

**Note:** This function works only if the function is set and turned on by writing-frequency software.

### **Emergency Alarm**

In the event of an emergency, you can use this function to ask your partners or control center for help. Emergency alarm has the highest priority, and you can alarm regardless of whether the radio is in the transmitter or receiver state.

**Note:** There are two cases where the alarm initiator exits the alarm mode:

- Press the [CALL] button or turn off the unit to exit alarm.
- When the alarm mode is exited in other modes (see below), the alarm on the current channel can only be temporarily exited, and the alarm will be resumed when the channel is re-selected. If other channel has alarm function, the radio will alarm again when it switches to the channel.

The activation of the alarm function is configured by the dealer (configuration path of writing frequency software: "Settings -> Signaling system -> Emergency alarm system -> System1"). Before using this function, you need to understand the following concepts.

### Alarm Type

The radio prompts in different modes for different alarm types, as shown in the following table.

Alarm type	Description
Disable	Turn off alarm function (alarm disabled)
Conventional	When alarms, the radio gives an audible and visual prompt.
Silent	When alarms, the radio will not give any audible or visual prompt. At the same time, no sound is made on any received audio.
Silence with voice	When alarms, the radio will not give any audible or visual prompt. However, the radio sounds when you press and hold the PTT button to initiate a call or respond to a call.

### Alarm Mode

Except the alarm type "Disable", other alarm types support the following alarm modes. You can ask the dealer to select one of them (**Note:** The following methods use "Conventional" alarm type as an example).

Alarm type	Description
Emergency alarm	In this mode, you can press and hold the [CALL] button to send an alarm tone to your partners or control center but can't talk to the other party.
Emergency alarm and call (alarm call)	In this mode, you can press and hold the [CALL] button to send an alarm tone to your partners or control center, and then press and hold the [PTT] button to speak to the microphone, and your voice and surrounding background sound will be sent to the receiver.
Emergency alarm and voice (emergency call)	In this mode, you can press and hold the [CALL] button to enter the alarm transmission channel. The product automatically activates the "emergency microphone" (without holding down the PTT button). You can speak to the microphone, and your voice and the surrounding background sound will be sent to receiver.

### Operation Method of Alarm in Digital Mode

The alarm system works only when the dealer has configured the "emergency alarm system" (such as the number of courtesy

transmissions, the number of non-courtesy transmissions, the number of emergency calls, the time of each transmission, and the transmission interval) of the current channel, and the contact of the reply channel of the emergency alarm system is group call.

## Emergency Alarm

### Initiate an Emergency Alarm

Press and hold the “Side button 1 (Call)” to enter the alarm mode; the red LED flashes, local and wireless alarm commands are sent. LCD interface displays : The first line shows Emergency Alarm, the second line shows the alarm group call contact alias, and the third line shows the group call number.

Exit Emergency Alarm

Alarm initiator can exit the alarm mode in the following ways:

- Press the [Call] button again.
- Press the [PTT] button.
- Turn off the unit.
- After the number of alarm cycles has been used, the radio will automatically exit the emergency alarm mode.

### Receive Emergency Alarm

The alarm information is displayed after receiving the alarm command, and LCD interface displays : The first line shows Receive Alarm, the second line shows Group Call, the third line shows the alarm alias or ID and sends local alarm; press the [PTT] button to exit.

Note: The alarm system works only when the dealer has configured the “emergency alarm system” of the current channel, and the contact of the reply channel of the emergency alarm system is group call.

## Alarm Call (Emergency Alarm and Call)

### Initiate an Alarm Call

1. Press and hold the “Side button 1 (Call)” to enter the alarm mode; the red LED flashes, local and wireless alarm commands are sent. LCD interface displays : The first line shows Emergency Alarm, the second line shows the alarm group call contact alias, and the third line shows the group call number.

2. Press and hold the [PTT] button to turn on the red LED, and speak to the microphone to send an emergency call.

**Note:** If you need to start an emergency call again when the number of emergency calls is used up, press and hold the [PTT] button.

### Exit Alarm Call

Alarm initiator can exit the alarm mode in the following ways:

- Press the [Call] button again.
- Turn off the unit.
- After the number of alarm cycles has been used, the radio will automatically exit the emergency alarm mode.

### Receive Alarm Call

The alarm information is displayed after receiving the alarm command, and LCD interface displays : The first line shows Emergency Call, the second line shows group call, the third line shows the alarm alias or ID and sends local alarm; press the [PTT] button to exit.

When the alarm is received, the green LED turns on, and you can hear the voice of the alarm originator and the background sound.

**Note:** The default reply channel prompts “Receive alarm” after receiving the alarm command, and LCD interface displays

: The first line shows Receive Alarm, the second line shows Group Call, and the third line shows the alarm alias or ID. Press the [PTT] button to exit.

**Note:** The alarm system works only when the dealer has configured the “emergency alarm system” of the current channel, and the contact of the reply channel of the emergency alarm system is group call.

## Emergency Call (Emergency Alarm and Voice)

### Initiate an Emergency Call

1. Press and hold the “Side button 1 (Call)” to enter the alarm mode; the red LED flashes, local and wireless alarm commands are sent. LCD interface displays : The first line shows Emergency Call, the second line shows the alarm group call contact alias, and the third line shows the group call number.
2. When the local alarm tone reaches the preset “non-courtesy retry”

count, the red LED turns on and automatically activates the “emergency microphone”; you can speak to the microphone to send an emergency call.

**Note:** It is not necessary to press and hold the PTT button to make emergency call. The product will automatically activate the emergency microphone, and you can speak to the microphone and send your voice and background sound to the receiver.



Exit Emergency Call

Alarm initiator can exit the alarm mode in the following ways:

- Press the [Call] button again.
- Turn off the unit.
- After the number of alarm cycles has been used, the radio will automatically exit the emergency alarm mode.

### Receive Emergency Call

The alarm information is displayed when the alarm command is received by the preset reply channel. The radio sends alarm sound after receiving the alarm command, and the LCD displays

. When the alarm voice is received, the green LED turns on and the LCD displays : The first line shows Emergency Call, the second line shows group call, and the third line shows the alarm alias or ID; you can hear the voice of the initiator and the background sound.

**Note:** The alarm receiver can't manually exit the alarm prompt, and when the alarm initiator exits alarm mode, the alarm receiver automatically exits alarm prompt.

## Alarm Operation Method in Analog Mode

### Initiate an Alarm

Press and hold the "Side button 1 (Call)" to enter the alarm mode, the red LED turns on, the alarm LED flashes, and the local alarm (alarm sound cycle at 5 seconds interval) and wireless alarm sound are sent.

### Exit Alarm

Alarm initiator can exit the alarm mode in the following ways:

- Press the [Call] button again.
- Turn off the unit.
- After the number of alarm cycles has been used, the radio will automatically exit the emergency alarm mode.

### Receive Alarm

Speaker outputs alarm sound (receives alarm sound 5 seconds and stops 5 seconds).

### Individual Operation

This feature is ideal for people who work alone. If you encounter unexpected situations during individual operation, you can't operate the radio in preset time. The radio will automatically send alarm to your partner or control center for help.

1. Turn on individual operation
  - Through writing frequency software, this function is turned on when the radio is started.
  - Press the preset [Individual Operation] shortcut to enable this function.

2. If you do not operate the radio in the preset response time, the radio will prompt before the response time is up (depending on the dealer settings). At this point, you can end the prompt with a valid physical operation (knob or button operation). When the response time is up, the radio will automatically turn on the alarm system of the current channel.

3. Turn off individual operation

- Turn this function off by writing-frequency software.
- Press the preset [Individual Operation] shortcut again to turn off this function.

Note: If you do not turn off the individual operation function before shutting down, the function is still active the next time you turn on the radio.

### Set Two-way Radio

You can set the radio as follows according to your own preferences and actual needs to maximize the effectiveness.

Setting method: Enter "Settings ->Radio settings" menu, and select the appropriate settings. You can also press and hold the [MENU] button to enter the radio device.

**The setting options are as follows:**

Setting options	Option and range	Description of operation
Sub audio	Sub audio codec	Change the encoding and decoding of sub-audio. Enter "Sub-audio codec", press [A/B] to select digital sub-audio, press [▲]/[▼] to select digital sub-audio code, and press # to switch the positive phase (N) and negative phase (I). ● Press [A/B] to select "Sub-audio codec OFF", press [▲]/[▼] to select analog sub-audio frequency. ● You can also enter non-standard sub-audio manually with keypad, press the [MENU] button to confirm, and press [EXIT] to return.
	Sub audio decoding	Change the decoding of sub audio. Setting method is same as above
	Sub-audio coding	Change the coding of sub audio. Setting method is same as above
Squelch	0~9	Squelch can be set to 0~9, 0 is the lowest and squelch is always on; 9 is the deepest, about -116dBm
Transmission power	Low	Low power transmission
	High	High power transmission
Offline	ON	ON; the function works only when "Allow offline" of current channel of the host computer is ticked
	OFF	OFF
Broad band and narrow band	Narrow band	Narrowband works
	Broad band	Broadband works

Busy lock	OFF	Transmit when the channel is occupied
	Carrier wave	Press PTT to prohibit transmission when there is carrier wave
	Sub-audio / color code	Match sub-audio / color code forbidden
Transmission time limit	OFF	Off, no transmission limit
	15~495S	Alarm in 10 seconds before transmission, and prohibit transmission when the time is up; for example, when it is set to 60 seconds, alarm is sent for 10 seconds from the 50th second, and transmission is prohibited at the 60th second
Voice control	OFF	VOX is turned off;
	ON	It is not necessary to press PTT when this option is on; you can speak to transmit directly; voice sensitivity of the host computer can be set to 1~10, level 1 is the highest sensitivity level, and level 10 is the lowest sensitivity level
Dual standby	OFF	Switch upper and lower channels through the keypad; when the machine works in the main channel, the sub-channel can't transmit or receive
	ON	Scan main channel and sub-channel in turn; call is locked when the reception is effective; you can press PTT to talk with the other party
Digital encryption	OFF	Turn off encryption
	ON	Turn on encryption function, and the two sides must pair the key to make the call normally

Power saving switch	OFF	Turn off power saving mode
	ON	Turn on the power saving mode; power saving ratio is 1:4
Prompt tone	All tones	Options: Off/On. Turn off all tones when Off is selected, but do not include emergency alarm tone
	Call permission	Options: Off / Digital / Analog. Pressing the PTT button will transmit the signal through the channel and will sound a tone that prompts the user to start speaking. <ul style="list-style-type: none"> <li>● OFF: Turn off this function</li> <li>● Digital: Enable this tone only for digital channels</li> <li>● Analog: Enable this tone only for analog channels</li> </ul>
	Touch-tone	Options: Off/On. There is no prompt tone when Off is selected
	Call end tone	Options: Off/On. On: This feature will send prompt tone when the voice call is terminated.
Backlight	Normally on	Always on (power saving disabled)
	5~15 sec	Turn off the backlight automatically when the time is up
Keypad lock	Manual	Press and hold # to lock, press and hold it again to unlock
	5/10/15 sec	Auto lock; lock automatically at set time; press and hold # to unlock
Keypad lock	Manual	The indicator (transmission, receiving, boot, etc.) does not work when it is off

Keypad lock	5/10/15 sec	Auto lock; lock automatically at set time; press and hold # to unlock
Indicator	OFF	The indicator (transmission, receiving, boot, etc.) does not work when it is off
	ON	Default option is on
Power on password	Enter password	Input correct password to enter the setup menu; the password can be configured by default on host computer Options: On or Off / Changes boot password <ul style="list-style-type: none"> <li>● On or Off: Turn on if it is turned off, and turn off if it is turned on; when On is selected, you need to enter the correct password and press the MENU button to start the unit</li> <li>● Change boot password: You can enter a new password not more than 6 digits; please remember after changing</li> </ul>
Mode selection	S/N display	The channel mode is displayed by channel number
	Name display	The channel mode is displayed by channel name
	Frequency display	The channel mode is displayed by frequency mode
Boot interface	Picture	Display according to the picture provided by the customer
	Preset characters	Two lines, can be edited by host computer
Language selection	English	English version, including menu, call tips, call logs and all other interfaces



Language selection	Chinese	Simplified Chinese
Caller ID	OFF	OFF
	ON	When caller ID is turned on, the caller ID is displayed when there is incoming call; calling format: caller ID separator own ID
DTMF side tone	OFF	When DTMF code word is sent, the unit does not make sound
	ON	When DTMF code word is sent, the unit makes the sound
Scan recovery mode	Time scan	Time mode scan; continue scanning in 5 seconds after signal is searched
	Carrier scan	Carrier mode scan; wait for 5 seconds after the carrier disappears before continuing scanning when signal is searched
	Search scan	Search mode scan; stop scanning when signal is searched
PTT online/offline code	None	Do not send code when PTT is pressed
	Online code	Press PTT to send code; online code word is set by the host computer
	Offline code	Release PTT to send code; offline code word is set by the host computer
	Online /offline code	Send code when it is pressed or released
Delay in sending code	100~1000ms	The delay time before automatic transmission
Selecting dual waiting	Main channel	Press PTT in dual waiting state, the transmission frequency band depends on the frequency band pointed by the cursor of current band

Selecting dual waiting	Reception channel	Press PTT in dual waiting state, the transmission frequency band depends on the effective reception frequency band; in non-receiving state, press PTT to transmit in main channel frequency band
Signaling tail tone elimination	Frequency	Analog with sub-audio signaling, release PTT to send sub-audio tail tone elimination signaling
	120°	Analog with sub-audio signaling, release PTT to send 120° phase sub-audio signaling
	180°	Analog with sub-audio signaling, release PTT to send 180° phase sub-audio signaling
	240°	Analog with sub-audio signaling, release PTT to send 240° phase sub-audio signaling
Non-signaling tail tone elimination	OFF	Turn off tail tone elimination
	Frequency	Analog without sub-audio signaling, release PTT to send sub-audio tail tone elimination signaling
Across-relay tail tone elimination	OFF	OFF
	1~10	Step: 1 (500ms) When transmitting across the relay and retransmitting, after the transmitter releases the PTT key, the two-way radio enters receiving state. Due to the delay of relay, the instant signal transmitted by the relay can be received. The value of the menu item shall be adjusted to ensure that no noise of this two-way radio is generated when transmitting across the relay, so as to confirm whether the relay is operating. The menu item shall be set OFF.

OFF 1~10	OFF	OFF
	1~10	Step: 1 (200ms) When the signal is transmitted across the relay station and retransmitted by it, in order to confirm whether the relay station has retransmitted the signal for this two-way radio, the delay time of the relay station stopping transmitting shall be utilized to confirm that the signal has been retransmitted. The menu item is used to adjust the time of the noise. If the noise isn't needed, please set it as OFF
Input 001~128	Input 001~128	To save a channel, manually enter the channel number to be saved. If the input channel has a parameter, the word "CH" appears at the top right of the screen, which indicates that current channel has been saved and continuing operation will overwrite it. "--" indicates that empty channel can be saved. When the range is exceeded, it prompts "channel number is illegal or mustn't be deleted"
Input 001~128	Input 001~128	To delete a channel, manually enter the channel number to be deleted. If the input channel has a parameter, the word "CH" appears at the top right of the screen, which indicates that current channel has been saved and can be deleted. "--" indicates that current channel is empty. When the range is exceeded, it prompts "channel number is illegal or mustn't be deleted"

### Sub-audio

In analog channel, the speaker turns on only when the carrier wave and sub audio match in order to avoid receiving irrelevant call on the same frequency. Provide 51 sets of standard CTCSS (analog sub audio) and also support non-standard sub audio. Provides 108 sets of standard DCS (digital sub audio), and also support non-standard DCS.

Sub-audio can be set via writing frequency software on the reception or transmission CTCSS/DCS of analog channel or via the "Settings ->Radio Settings -> Sub Audio" path of this product. Enter "Sub audio codec", press the [A/B] button to select digital sub audio, press [▲]/[▼] to select digital sub audio code, press the # button to switch between positive phase (N) and negative phase (I).

- Press the[A/B]button to select "Sub audio codec", and press [▲]/[▼] to select analog sub audio frequency.
- You can also enter the non-standard sub audio manually through the keypad, press the [MENU]button to confirm, and press the[EXIT]button to return.
- In "Sub audio codec "mode, press the \* button to scan analog sub audio.

### View Radio Info

View the information about this product, including: own number and radio model, serial number, CPS version, hardware version, firmware version, DSP version, and programming time.

- Own number menu path: Settings ->Radio Information ->Own Number.

- Device info menu path: Settings ->Radio Information -> Device Info.

### Configuring Two-way Radio

The product configuration is listed below:

Configuration item	Operating instructions
Reception frequency	To set reception frequency; press * to clear all, press EXIT to delete one
Transmission frequency	To set transmission frequency; press * to clear all, press EXIT to delete one
Channel name	To set channel name; press * to clear all, press EXIT to delete one
Color code	Options: 0~15 optional ● Valid for digital mode only
Time slot	Options: 1~2 optional ● Valid for digital mode only
Difference frequency	000000~50000K, the minimum step value is 50K The difference between transmission frequency and reception frequency in frequency mode, whether frequency has difference depends on frequency direction
Difference frequency direction	Options: Off / Positive / Negative ● Off: Transmission frequency and reception frequency have no difference in frequency mode ● Positive: In frequency mode, the transmission frequency is equal to the reception frequency plus the difference frequency ● Negative: In frequency mode, the transmission frequency is equal to the reception frequency minus the difference frequency

Frequency step Channel type	Options: 2.5K/5.0K/6.25K/10K/12.5K/25K/50K ● In the frequency mode, press [ ▲ ]/[ ▼ ]to adjust the frequency value in steps; scan in steps in frequency mode
Difference frequency direction	Options: Analog / Digital ● Switch analog and digital mode in frequency mode

You can modify the frequency of current channel, channel name, color code, relay station time slot and other radio configuration information.

Configuration path: Enter “Settings ->Radio Configuration” menu, and select the appropriate configuration items.

- Frequency: Set the reception frequency and transmission frequency. Please use the frequency in the range of this product.

**NOTE:**The frequency will be modified according to the frequency range set on the writing frequency software. If the limit frequency range is exceeded, the LCD displays “Illegal reception frequency” or “Illegal transmission frequency”, the modified value is invalid and returns.

- Color code : Color code can mark a system, and the terminals that communicate with each other must set the same color code. Range: Integer from 0 to 15.

- Relay time slot : Select the time slot for voice calls and data transmission.

**NOTE:**The digital channel of host computer can be configured to dual capacity direct mode. This mode supports parallel direct mode transmission of two two-way radios transmitting on

12.5KHz channel bandwidth. The radios in the same communication group must use the same time slot, and the group using slot 1 will not interfere with the group using slot 2.

## Appendix

### Online Update

1. Turn off the radio, and insert the writing frequency line;
2. Press and hold the [Side button 1] and [Side button2] at the same time to turn on the radio, the green LED turns on, and the screen is black, indicating that the radio has entered the upgrade mode;
3. Start the upgrade software "Update.exe" on the computer; select the corresponding serial port;
4. Click "Browse" to select the file to be upgraded (provided by the manufacturer), for example: DMR-5R-V1.1.1.sgl;
5. Click "Download" and wait the download to complete. Remember that the power mustn't be cut off in the update process, or else the SCM will be scrapped;
6. Unplug the writing frequency line, turn off the radio or reboot.

**NOTE:** Caution: Do not cut off the power in the update process, or else the SCM will be scrapped.

### Aging Test

In power off mode, press and hold the [Side button 1] and the number button [2] to turn on the radio and enter the aging test, the radio displays " RF Test ...", the transmitter LED turns on and

transmits 30 seconds, then the receiver LED turns on and receives for 30 seconds; the transmitter and receiver alternate until the power is used up. The radio can be turned off in the aging process, and the aging channel is the channel entered after turning on (either analog channel or digital channel).

### Initialize Defaults

In power off mode, press and hold the [Side button 1] and the number button [1] to turn on the radio, and the LCD displays "Memory Reset?"; press the MENU button to enter initialization, and the LCD displays "Memory Reset..."; the initialization finishes after 10 seconds and the radio turns on normally. Press other buttons to exit the initialization interface and boot normally.

**NOTE:** The power mustn't be cut off in the initialization process, or else the initialization will fail.